



Technical parameters	RFDEL-71M/230V	RFDEL-71M/120V
Supply voltage:	230 V AC	120 V AC
Supply voltage frequency:	50 Hz	60 Hz
Apparent power:	2.5 VA	1.1 VA
Dissipated power:	0.8 W	0.6 W
Supply voltage tolerance:	+10 / -15 %	
<b>Output</b>		
Dimmed load:	R,L,C, LED, ESL	
Contactless:	2 x MOSFET	
Load capacity:*	max. 600 W	max. 300 W*
<b>Control</b>		
Wireless:	up to 32 channels (buttons)	
Communication protocol:	RFIO2	
Frequency:	866–922 MHz (for more information see p. 80)	
Repeater function:	yes	
Range:	in open space up to 160 m	
Manual control:	SW (ON/OFF) button	
External button:	max. 50 m cable	
Glow lamps connection:	NO	
Analog control:	potentiometer or 0 (1) - 10 V	
RF Antenna:	AN-I included (SMA connector**)	
<b>Other data</b>		
Operating temperature:	-20 to + 35 °C	
Storage temperature:	-30 to +70°C	
Operating position:	vertical	
Mounting:	DIN rail EN 60715	
Protection:	IP20 under normal conditions	
Overvoltage category:	II.	
Contamination degree:	2	
Cross-section of connecting wires:	max. 1x 2.5, max. 2x 1.5 / with a hollow max. 1x 2.5	
Dimensions:	90 x 52 x 65 mm	
Weight:	125 g	
Related standards:	EN 607 30-1 ed.2	

\* See page 79 for the load chart for each light source.  
 \*\* Max. Tightening Torque for antenna connector is 0.56 Nm.

- The universal modular dimmer is used to regulate light sources:
  - R – classic lamps (resistive load)
  - L – halogen lamps with wound transformer (inductive load)
  - C – halogen lamps with electronic transformer (capacity load)
  - ESL – dimmable energy-efficient fluorescent lamps
  - LED – LED light sources equipped with LED.
- Control can be performed by:
  - a) detectors, Controllers and System units iNELS RF Control
  - b) by control signal 0(1)-10 V
  - c) potentiometer
  - d) existing button in the installation.
- 6 light functions - smooth increase or decrease with time setting 2 s -30 min. Function description can be found on page 79.
- Thanks to setting the min. brightness by potentiometer, you will eliminate flashing of the LED and ESL light sources.
- The universal dimmer may be controlled by up to 32 channels.
- The programming button on the controller is also used for manual control of the output.
- The package includes an internal antenna AN-I , in case of locating the unit in a metal switchboard, you can use the external antenna AN-E for better signal reception.
- Memory status can be pre-set in the event of a power failure.
- Range up to 160 m (in open space), if the signal is insufficient between the controller and unit, use the signal repeater RFRP-20 or protocol component RFIO2 that support this feature.
- Communication frequency with bidirectional protocol RFIO2.
- The unit’s three-module design with switchboard mounting.

**Device description**

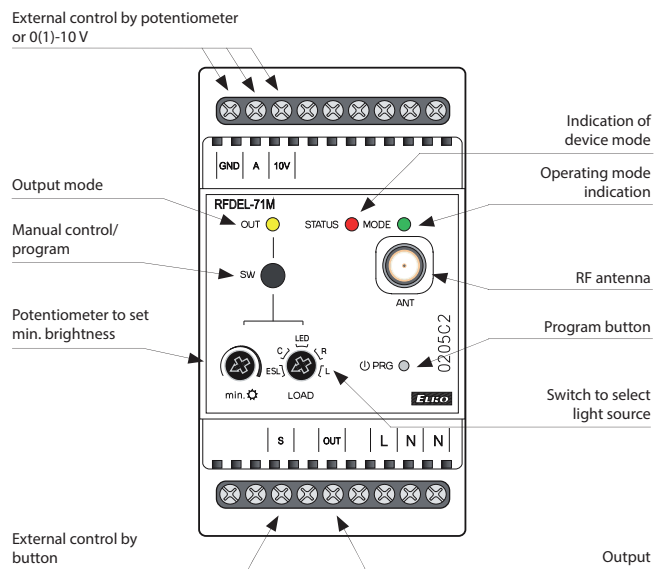

**Connection and external control options**

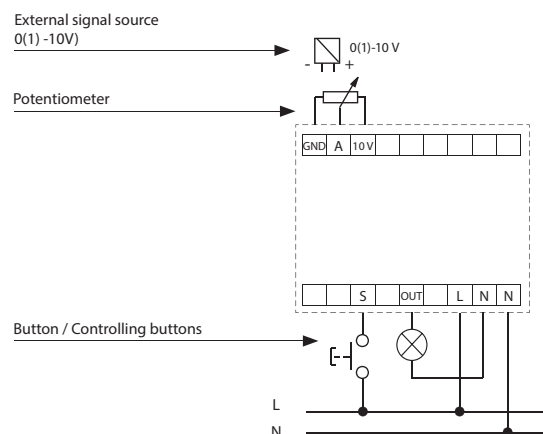

Multi-function RFDA-73M/RGB, RFDEL-71B, RFDEL-71M, RFDSC-71, RFDAC-71B, RFDW-71

Light scene function 1

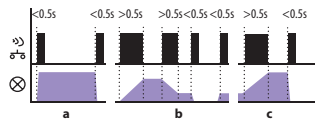

- a) By pressing the programmed button for less than 0.5 s, the light illuminates; it goes out by pressing again.
  - b) By pressing the programmed button for more than 0.5 s, fluid brightness regulation will occur. After releasing the button, the brightness level is saved in the memory, and pressing the button shortly later will switch the light on/off to this intensity.
  - c) It is possible to readjust the change in intensity at any time by a long press of the programmed button.
- The actuator remembers the adjusted value even after disconnecting from the power supply.

Light scene function 3

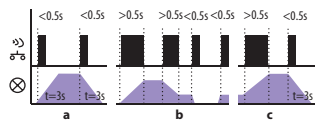

- a) By pressing the programmed button for less than 0.5 s, the light fluidly illuminates for a period of 3 s (at 100% brightness). By pressing the button shortly again, the light will continuously switch off for 3 seconds.
  - b) By pressing the programmed button for more than 0.5 s, fluid brightness regulation will occur. After releasing the button, the brightness level is saved in the memory, and pressing the button shortly later will switch the light on/off to this intensity.
  - c) It is possible to readjust the change in intensity at any time by a long press of the programmed button.
- The actuator remembers the adjusted value even after disconnecting from the power supply.

Function sunrise

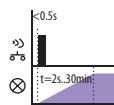

After pressing the programmed button, the light begins to illuminate in the programmed time interval in a range of 2 seconds to 30 minutes.

Function ON/OFF

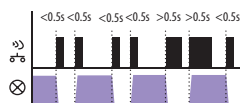

If the light is switched off, pressing the programmed button will switch it on. If the light is switched on, pressing the programmed button will switch it off.

Light scene function 2

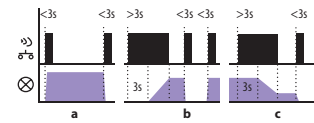

- a) By pressing the programmed button for less than 3 s, the light illuminates; it goes out by pressing again.
  - b) In order to limit undesirable control of brightness, fluid brightness control occurs only by pressing a programmed button for over 3 s. After releasing the button, the brightness level is saved in the memory, and pressing the button shortly later will switch the light on/off to this intensity.
  - c) It is possible to readjust the change in intensity at any time by pressing the programmed button for over 3 s.
- The actuator remembers the adjusted value even after disconnecting from the power supply.

Light scene function 4

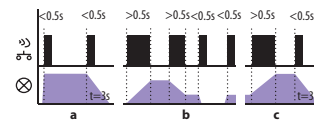

- a) By pressing the programmed button for less than 0.5 s, the light illuminates. By pressing the button shortly again, the light will continuously switch off for 3 seconds (at 100% brightness).
  - b) By pressing the programmed button for more than 0.5 s, fluid brightness regulation will occur. After releasing the button, the brightness level is saved in the memory, and pressing the button shortly later will switch the light on/off to this intensity.
  - c) It is possible to readjust the change in intensity at any time by a long press of the programmed button.
- The actuator remembers the adjusted value even after disconnecting from the power supply.

Function sunset

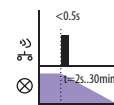

After pressing the programmed button, the light begins to dim in the programmed time interval in a range of 2 seconds to 30 minutes.

Function switch off

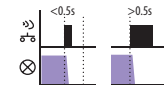

The dimmer output switches off by pressing the button.

Rating of the light source ELKO lighting on dimmers ELKO EP

	LED bulb		LED spot lights			LED panels		LED / RGB strip					
	DLB-E27-806-2K7	DLB-E27-806-5K	DLSL-GU10-350-3K	LSL-GU10-350-3K	LSL-GU10-350-5K	LP-6060-3K	LP-6060-6K	LED strip 7.2W	LED strip 14.4W	LED strip 19.2W	LED strip 28.8W	RGB strip 7.2W	RGB strip 14.4W
RFDSC-71	✓ 21	✓ 21	✓ 45	✓ 25	✓ -	- -	- -	- -	- -	- -	- -	- -	- -
RFDEL-71B	✓ 11	✓ 11	✓ 25	✓ 13	✓ 13	- -	- -	- -	- -	- -	- -	- -	- -
RFDA-73M/RGB	- -	- -	- -	- -	- -	- -	- -	✓ 3x8m	✓ 3x4m	✓ 3x5m	✓ 3x4m	✓ 20m	✓ 10m
RFDAC-71B	- -	- -	- -	- -	- -	✓ 50	✓ 50	- -	- -	- -	- -	- -	- -

WARNING!

May lead to different results based on the state of network cable length and other factors.

This table contains the results of tests that were conducted internally and therefore is ONLY for customers only informative. The products were tested in test laboratories ELKO EP, and therefore the company assumes no responsibility for any imitation test environment.

**Inductive and capacitive loads must not be connected simultaneously!**

Load capacity:

\* Due to the huge amount of type of light sources, the maximum load depends on internal construction of dimmable LED and ESL bulbs and their power factor  $\cos \varphi$ , capacity for power factor  $\cos \varphi = 1$ . The power factor of dimmable LEDs and ESL bulbs ranges from  $\cos \varphi = 0.95$  up to 0.4. An approximate value of maximum load may be obtained by multiplying the load capacity of the dimmer by the power factor of the connected light source.